

3.2

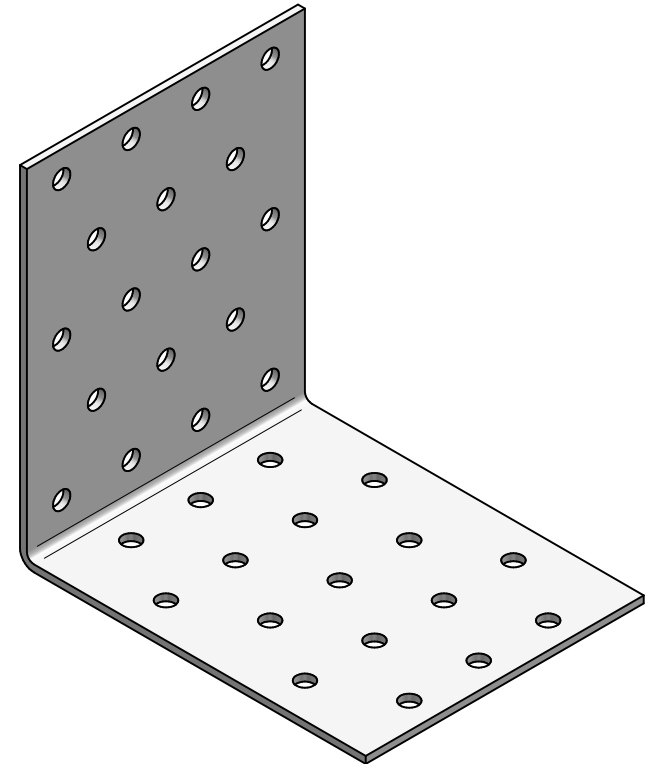

Hole	Size	Count
A	5 mm	35

Product name: Angle bracket 100x100x80x2,0
Material: HDG DX51D Z275