

3.2

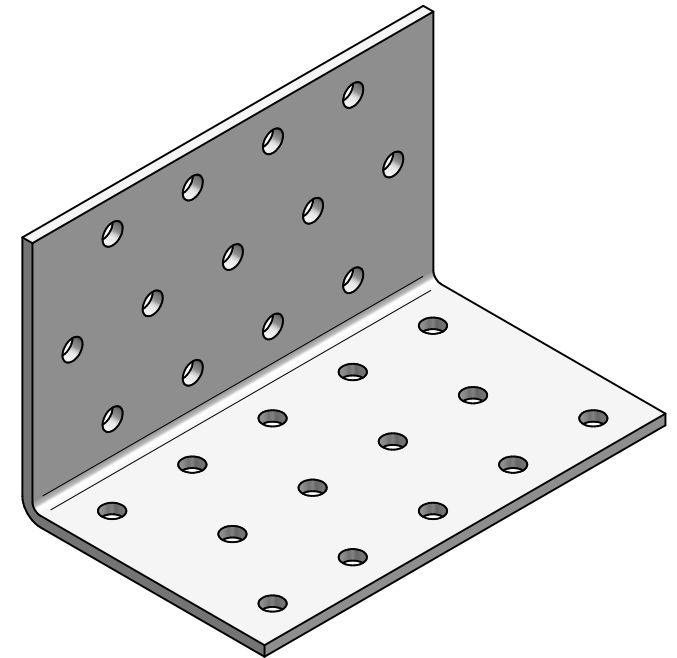
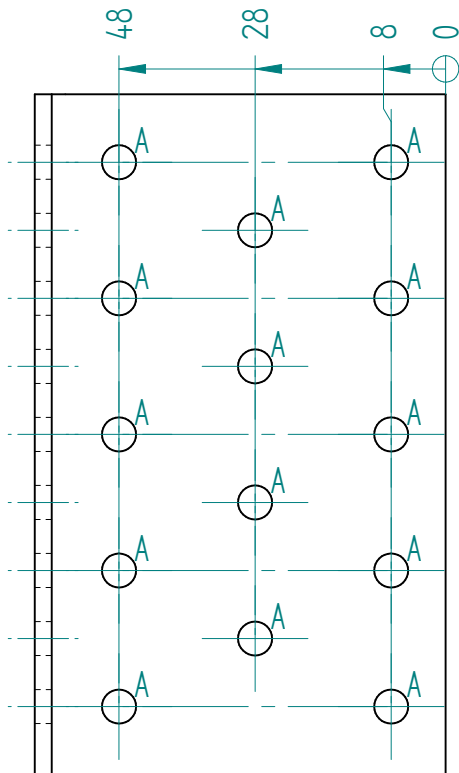

Hole	Size	Count
A	5 mm	27

Product name: Angle bracket 60x60x100x2,5
Material: HDG DX51D Z275